

RPC



Description

The RPC tapered transformation pieces have male ends which slip into spiral ducts or plain ducts. The safe-edge ends have hemmed rims. This reducer helps to save installation space, but it increases the flow resistance compared to RSCL long reducers. Standard nominal diameters up to DN 315 mm are available for pressed pieces at a lower price and with an improved finish. The air tightness can be increased to class B by wrapping the joints with the TAL, MET or DUCT sealing tape.

Available materials — Product code example

RPC-...-... – galvanized steel sheet

Product code example

Product code: **RPCL - aaa - bbb**

type	
Ød ₁	
Ød ₂	

Dimensions

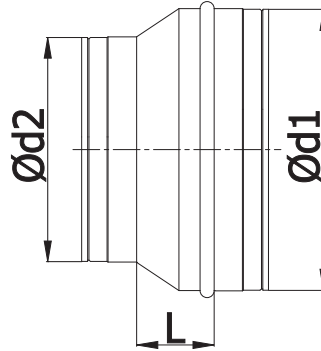

Ød _{1 nom} (mm)	Ød _{2 nom} (mm)	L (mm)	Weight (kg)
100	80	18	0.20
125	80	28	0.20
	100	22	0.20
140	100*	30	0.20
	125	30	0.20
150	100	35	0.20
	125	30	0.20
	140	30	0.30
160	80	48	0.30
	100	37	0.30
	125	26	0.20
	140	30	0.30
	150	30	0.30
180	125*	40	0.30
	140*	30	0.30
	150*	30	0.30
	160	30	0.30
200	100	58	0.40
	125	46	0.40
	140*	40	0.30
	150	35	0.30
	160	26	0.30
	180	30	0.30
224	150*	50	0.40
	160*	50	0.40
	180*	30	0.40
	200	30	0.40

RPC

Dimensions

$\varnothing d_{1, nom}$ (mm)	$\varnothing d_{2, nom}$ (mm)	L (mm)	Weight (kg)
250	125	70	0.50
	150	60	0.50
	160	53	0.50
	180*	50	0.40
	200	31	0.60
	224*	50	0.50
	280	160*	80
180*		70	0.60
200*		60	0.60
224*		40	0.60
250*		30	0.50
300	200*	70	0.70
	224*	60	0.70
	250*	30	0.60
	280*	30	0.70
	315	160	88
180*		90	0.80
200		68	0.70
224*		60	0.70
250		43	0.70
280*		40	0.70
300*		38	0.70
355		200*	110
	224*	90	1.00
	250*	70	1.00
	315*	30	0.90
400	200*	140	1.50
	224*	120	1.40
	250*	100	1.30
	315*	60	1.30
	355*	30	1.20
450	250*	140	2.00
	280*	110	1.90
	300*	100	1.90
	315*	90	1.80
	355*	60	1.70
	400*	40	1.70
500	250*	128	2.20
	300*	140	2.40
	315*	120	2.20
	355*	100	2.20
	400*	70	2.10
	450*	40	2.10

$\varnothing d_{1, nom}$ (mm)	$\varnothing d_{2, nom}$ (mm)	L (mm)	Weight (kg)
560	315*	170	2.90
	355*	140	2.80
	400*	110	2.70
	450*	80	2.60
	500*	75	2.60
600	400*	130	3.10
	450*	100	3.00
	500*	70	2.70
	560*	30	2.40
630	315*	160	3.20
	400*	140	3.30
	450*	120	3.30
	500*	80	3.00
	560*	75	2.90
600*	30	2.50	

*Segmented versions; other versions are pressed only.

Technical specifications

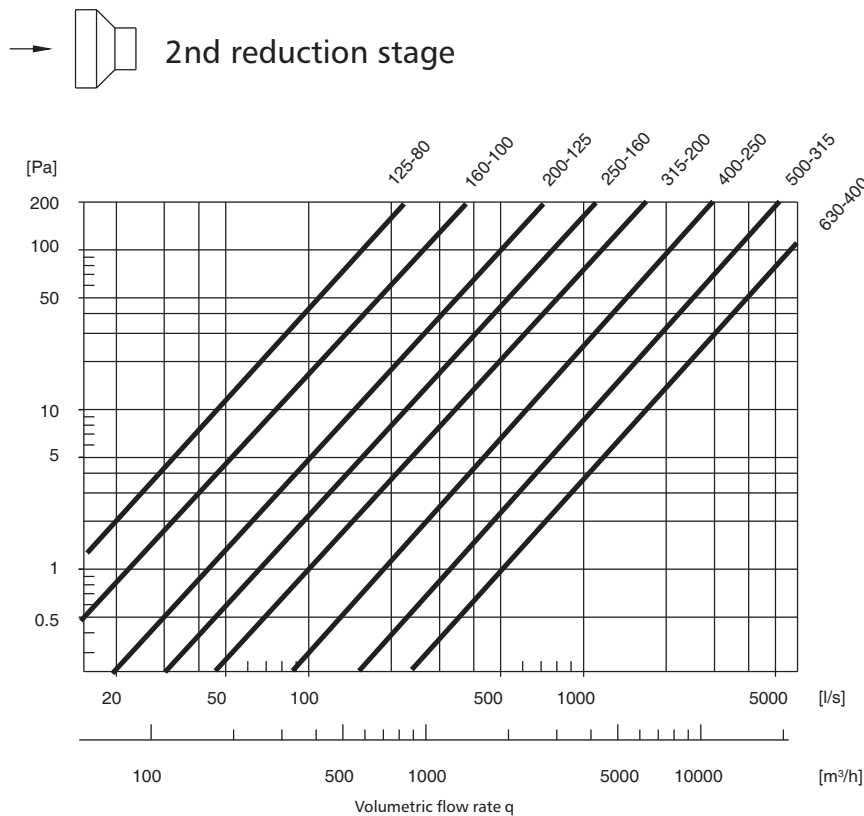
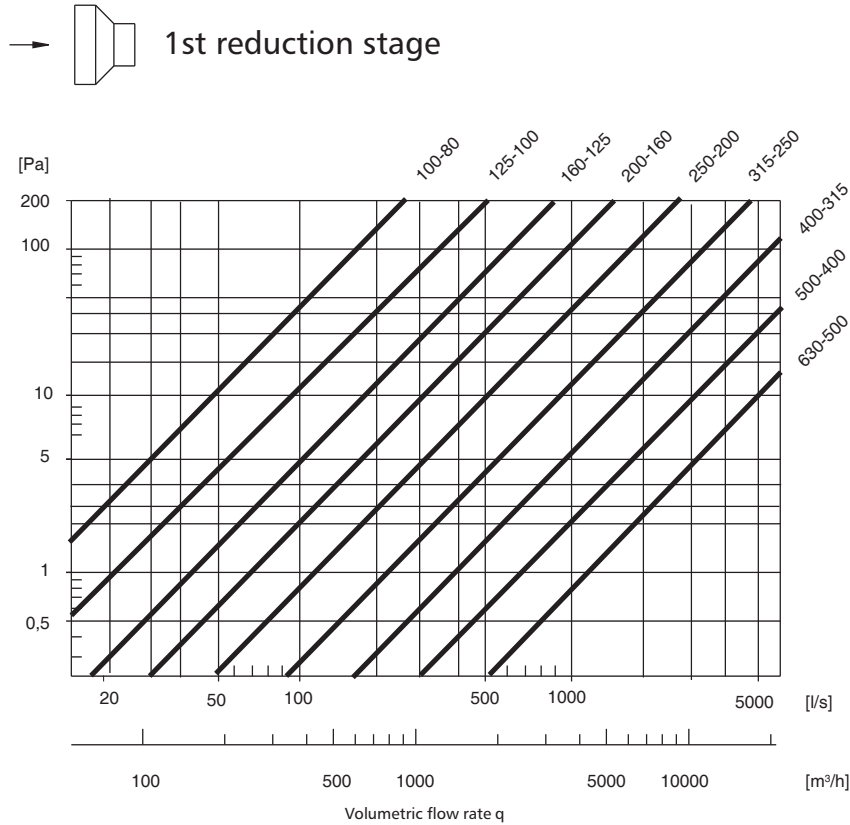

Ventilation duct reducers

RPCL/RPCFL/RPC/RPCF

Technical specifications

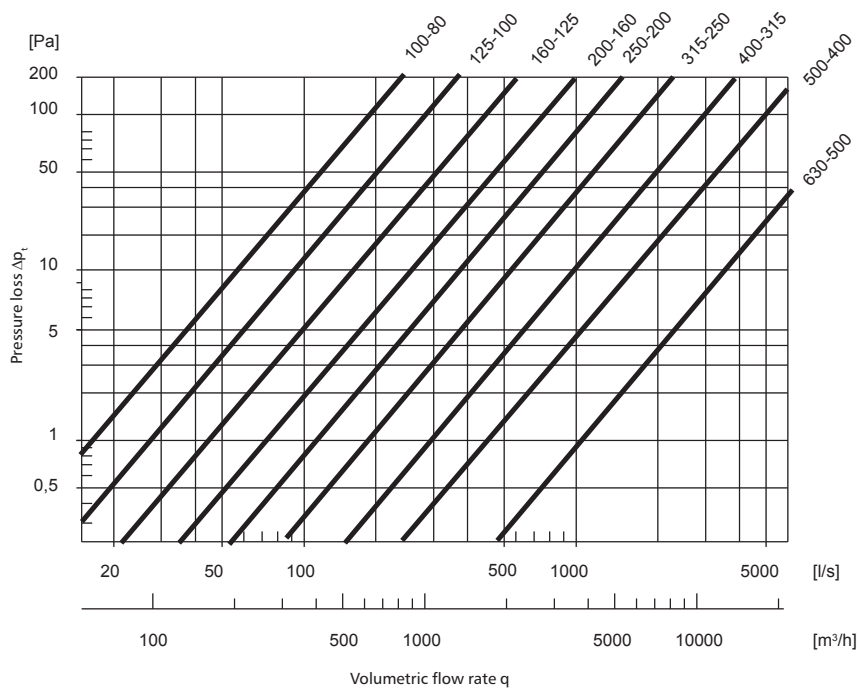
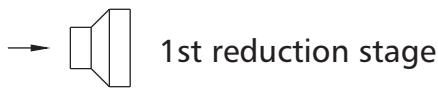
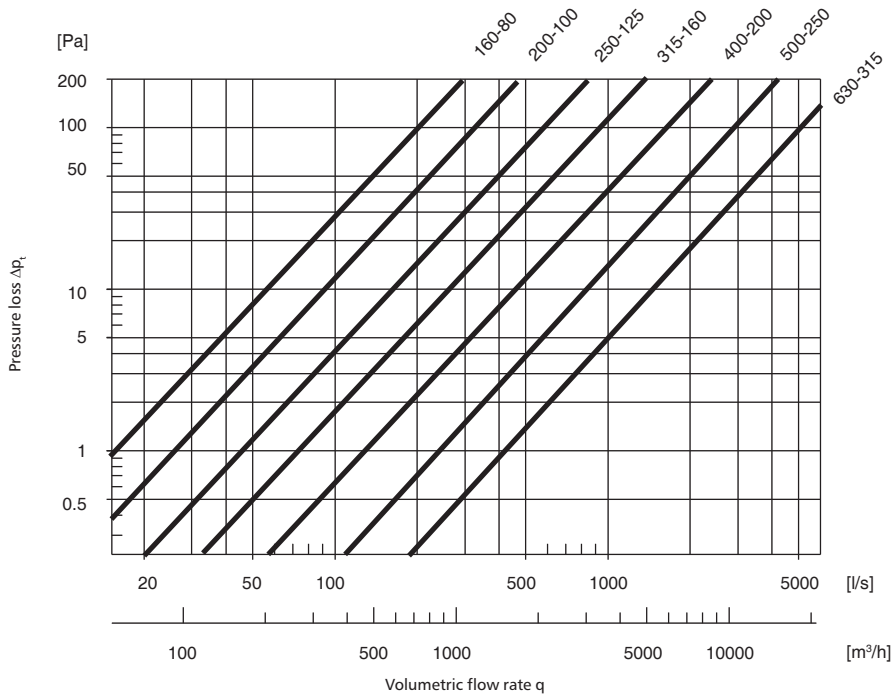
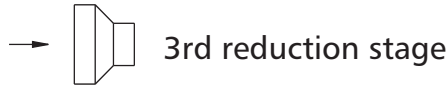

Ventilation duct reducers

RPCL/RPCFL/RPC/RPCF

Technical specifications

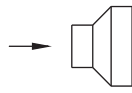

2nd reduction stage

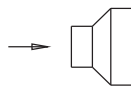
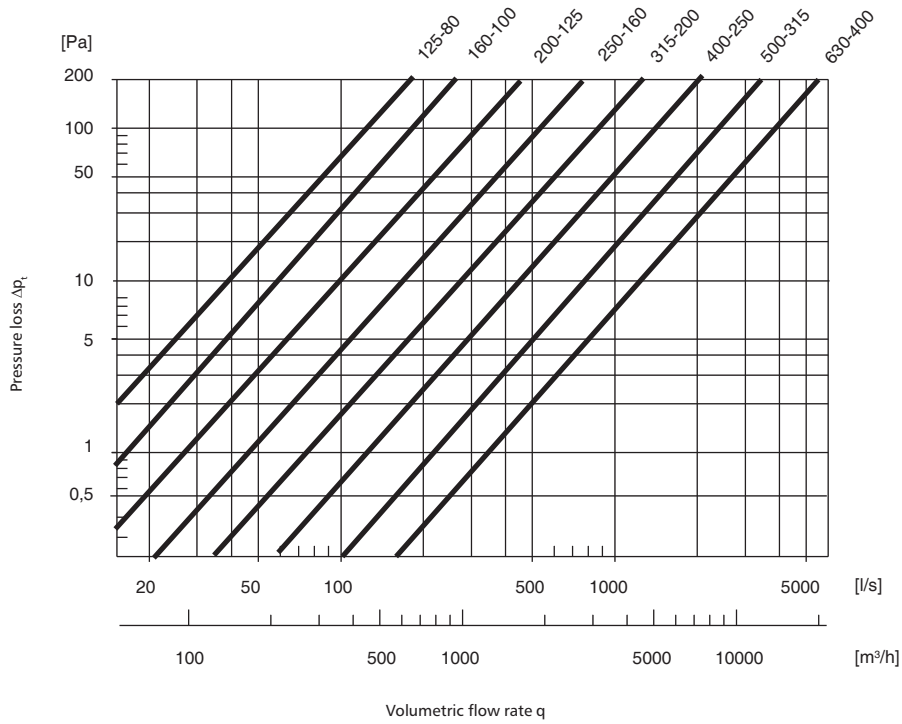

3rd reduction stage

